

Operating Instructions

Data Logger with external sensors

BA-OP20E-02-EN

Table of Contents

Contents	Page
1. Safety Instructions	2
2. Intended Purpose and Use	2
3. Features	3
4. Scope of Delivery	4
5. Preparations Prior to Use	4
5.1. Software	4
5.1.1. Installation Requirements	4
5.1.2. Installing the SmartGraph Software	4
5.1.3. Preparing the Data Logger Configuration	4
6. Operating the Data Logger	4
6.1. Powering ON/OFF	4
6.2. Basic Settings and Operating Modes	4
6.2.1. The Four Operating Modes	5
6.2.2. Network Function (M51)	5
6.2.3. Factory Setting (M52)	5
6.2.4. Acoustic Function (M53)	5
7. Connecting and Configuring External Sensors	6
7.1. BUS Sensors	6
7.1.1. Connecting BUS Sensors	6
7.1.2. Configuring BUS Sensors (M6x)	6
7.1.3. Logging off BUS Sensors (M7x)	6
7.2. Connecting Analog Sensors	6
7.2.1. Voltage Measurement Sensors: 0 - 1V	7
7.2.2. Voltage Measurement Sensors: 2-wire 4 - 20 mA and 3-wire 0 - 20 mA	7
7.2.3. Pt100 Sensors in 3-wire and 4-wire Circuit	7
7.2.3. Thermocouples	7
7.3. Configuring Analog Sensors (M81)	7
8. Measurement Value Display and Data Logging	8
8.1. Channel Groups and Measurement Channels	8
8.2. Calculation Channels for Measurement Conversion	10
8.3. Displaying Measurement Values	10
8.4. Data Logging	10
9. Alarm Function	10
9.1. Alarm Configuration	10
9.2. Alarm Symbol on the Display	10
9.3. Acoustic Alarm	10
9.4. Using the Alarm Hysteresis	11
10. Cleaning and Maintenance Instructions	11
10.1. Replacing the Batteries	11
10.2. Installation During Mobile Operation	11
10.3. Mounting the Logger on a Wall	11
10.4. Changing Locations	11
11. Technical Data	12
12. Error Codes	13

This publication replaces all previous publications. No part of this publication may be reproduced, processed using electronic systems, replicated or distributed in any way without our prior written authorisation. Subject to technical modifications. All rights reserved. Names of goods are used without guarantee of free usage and used for the most part according to the manufacturers syntax. The names of goods used are registered and should be considered as such. We reserve the right to modify the design in the interest of ongoing product improvement, such as shape and colour modifications. The scope of delivery may vary from that in the product description. All due care has been taken in compiling this document. We accept no liability for any errors or omissions.

Please read this manual carefully. These instructions are designed to ensure that your data logger is used for the purpose for which it was intended and to guarantee that you get the maximum benefit from your product.

These **operating instructions** describe the functions of the hardware.

There is also a separate **software manual** available. This manual shows you how to configure your data logger and how to use the software. The manual can be accessed using the Help function as soon as it has been installed.

Your new data logger was designed and manufactured in line with the latest technological advancements and complies with the requirements as laid down in existing European and national guidelines. Conformity has been certified. The relevant declarations and documents are in the possession of the manufacturer.

As the user you must read and adhere to the following safety instructions in order to ensure that this condition is maintained and that no danger results from the use of this device:

1. Safety Instructions

We do not accept any liability for any damages which might occur as a result of improper use or the non-observance of these instructions. The guarantee expires with immediate effect in any such case.



These instructions must be read in full before this measuring device is put into operation for the first time.

For reasons of safety and CE compliance you may on no account carry out any changes or modifications on either the device itself or any other components which may be used in connection with this measuring device.

The following instructions must be adhered to before the device is taken into use:

- Do NOT carry out measurements on live components.
- Please observe the sensor measuring range.
- Please observe the operating and storage conditions.
- The user is solely responsible for determining whether he or she considers the measurement results to be valid and for any conclusions that are reached or any measures that are taken as a result thereof. We can neither guarantee the validity of any measurement results nor can we accept liability for any such results. We are on no account able to accept liability for any damage which may be caused as a consequence of the use of these measurement results.

2. Intended Purpose and Use

The data logger is used to detect and log various measurement variables which the measuring instrument collects using connected external sensors. The measurement data can be logged, called up or saved to a connected PC at randomly selectable intervals.

This measuring device may only be used within the specified technical specifications for the purpose for which it was intended.

Any other use is considered to be improper and constitutes a violation of these conditions.

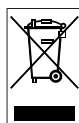

This product should not be disposed of in your general waste. Please ensure that it is disposed of in an orderly manner in accordance with existing regulations.

3. Features

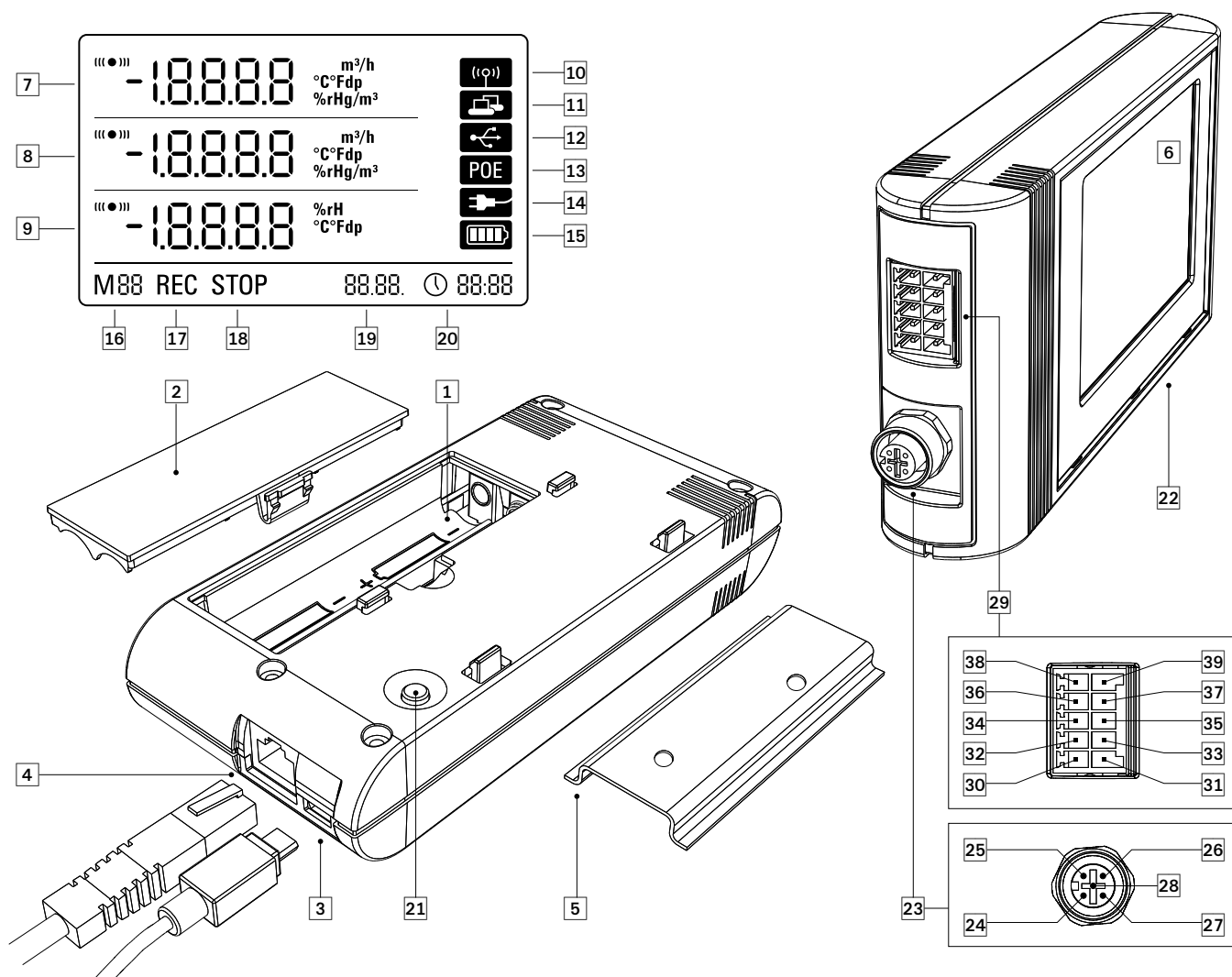

- ① Battery compartment
- ② Battery compartment lid
- ③ USB micro B port
- ④ RJ45 network connection
- ⑤ Mounting rail
- ⑥ LCD display :
 - ⑦ Measurement value line 1
 - ⑧ Measurement value line 2
 - ⑨ Measurement value line 3
 - ⑩ Display symbol acoustic signal active
 - ⑪ Display symbol network connection active
 - ⑫ Display symbol USB connection active
 - ⑬ Display symbol power supply via mains
 - ⑭ Display symbol power supply via USB
 - ⑮ Display symbol battery capacity
 - ⑯ Display symbol mode marker
 - ⑰ Display symbol logging active
 - ⑱ Display symbol logging inactive
 - ⑲ Date display
 - ⑳ Time display
- ⑳ Mode selection key
- ㉑ Data logger for connecting external sensors
- ㉒ 5-pin circular connector M12 for connecting up to four digital bus-compatible sensors:
 - ㉓ Pin 1: Sensor power supply (output)
 - ㉔ Pin 2: Data 1
 - ㉕ Pin 3: Data 2
 - ㉖ Pin 4: GND (reference potential)
 - ㉗ Pin 5: n.c. (not connected)
- ㉘ 10-pin connector with two independent input channels for connecting up to two analog sensors:
 - ㉙ Pin 1: Terminal +24V (input, external power supply data logger (24 V) for stationary operation)
 - ㉚ Pin 2: Terminal GND (supply voltage GND)
 - ㉛ Pin 3: Terminal A1
 - ㉜ Pin 4: Terminal B1
 - ㉝ Pin 5: Terminal C1
 - ㉞ Pin 6: Terminal D1
 - ㉟ Pin 7: Terminal A0
 - ㊱ Pin 8: Terminal B0
 - ㊲ Pin 9: Terminal C0
 - ㊳ Pin 10: Terminal D0

4. Scope of Delivery

The following components are contained in the standard scope of delivery:

- Data logger
- USB cable
- CD-ROM with operating instructions, SmartGraph software and software manual
- 4 x AA batteries
- Factory certificate

5. Preparations Prior to Use

5.1. Software

5.1.1. Installation Requirements

Your SmartGraph software has to be installed on to a PC that fulfils the following requirements in order for you to be able to configure your data logger and read out the measurement results that have been recorded.

Supported operating systems:

- Windows XP from Service Pack 3 (32 bit or 64 bit version)
- Windows Vista (32 bit or 64 bit version)
- Windows 7 (32 bit or 64 bit version)

Hardware requirements:

- Processor speed: at least 1.0 GHz
- CD ROM drive
- USB or RJ45 network connection
- At least 512 MB main storage
- At least 4 GB free hard disk storage
- Adobe Acrobat Reader software

5.1.2. Installing the SmartGraph Software

Place the CD ROM in the drive of your PC and follow the instructions of the installation assistant to install the software.

5.1.3. Preparing the Data Logger Configuration

First of all, connect the external sensors as required for measurement purposes to the external connections on your data logger.

You will find information about connecting and configuring appropriate sensors in chapters 7 and 11. To connect external sensors, first follow the instructions in chapter 7 and then return to this section to continue commissioning.

The next step is to connect the data logger to your PC using the USB cable provided as part of the delivery. The SmartGraph software detects the measuring instrument automatically.

Alternatively, if a network function is enabled you can also configure your data logger via a LAN connection on your local network. You will find more information about the network function in chapter 6.2.2.

Start the SmartGraph software. The program recognises the connected data logger automatically and adds the data logger to the existing data logger list. The data logger can now be configured using the software.

You will find more detailed information on the software in the software manual which you can call up using the Help function of your SmartGraph software.

Functions of the Professional Version

You will find information on the possibility of upgrading your SmartGraph software to the professional version (Device Licence Upgrade) in the software manual.

6. Operating the Data Logger

The SmartGraph PC software forms the central configuration interface for your data logger. All further changes to the configuration or display can only be carried out using the software.

You can use the mode selection keys on your data logger to carry out basic settings directly.

You can also use the software to lock the mode selection keys. In such a case the data logger cannot be configured via the mode selection keys.

6.1. Powering ON/OFF

The data logger cannot be switched off completely when connected to a functioning power supply. It can, however, be switched to a low-energy power mode (M1) which allows it to consume as little power as possible. The data logger is inactive in this mode and therefore unable to carry out measuring or logging or display any values. You will find an overview of the four different modes in the following chapter.

6.2. Basic Settings and Operating Modes

The mode selection key on the data logger can be used to configure eleven basic settings as follows: four basic operating modes, network function, global settings reset, acoustic function and various settings for configuring external sensors.

Press the mode selection key briefly to access the settings level which you have currently selected.

Press the mode selection key again to navigate from one setting mode to another.

The selected mode will appear on the display for a maximum of four seconds. During this time the mode can be selected.

During this time, the mode marker (M1, M2, M3, M4, M51, M52, M53, M6x, M7x, M81 (An0), M81 (An1)) flashes in the lower left corner of the display.

Press the mode selection key longer (approx. 1 second) to confirm your selection.

The data logger will then change into the selected mode.

If you do not confirm your selection within this four-second period, then the device will leave the settings level and return to the mode that had previously been selected.

* The function is only available if a BUS sensor is logged on before (M61)

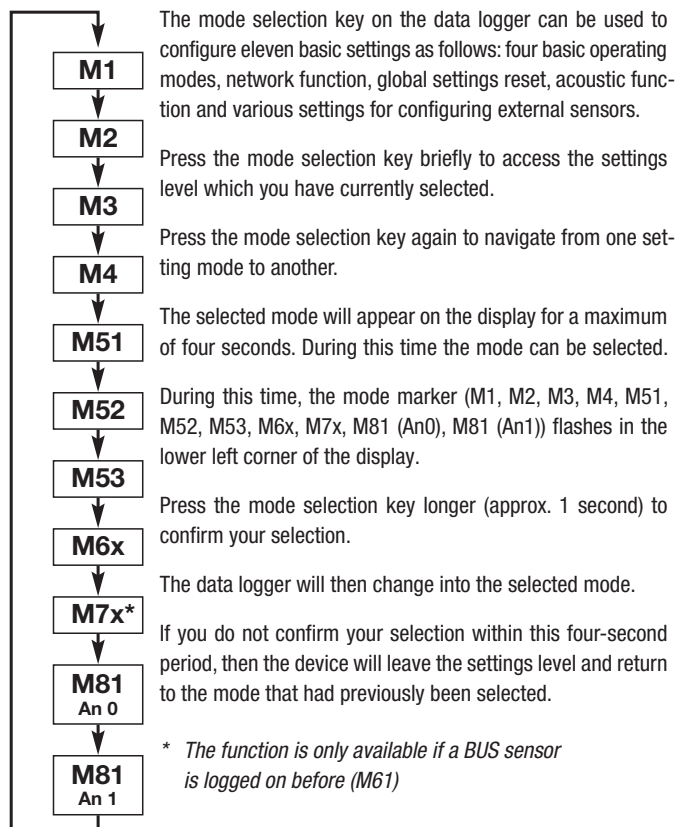

6.2.1. The Four Operating Modes

Operating mode M1

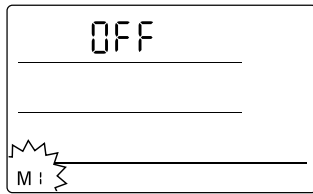

Select operating mode M1

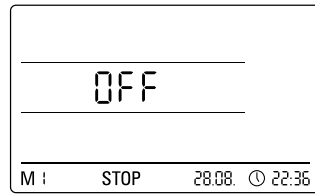

Display operating mode M1

The logging function is inactive. The word “OFF” appears in measurement value line 1. The “STOP” symbol is active.

In this mode (data logger factory setting), the energy consumption is low, because there are not yet any measurement values which could be called up or displayed.

Operating Mode M2

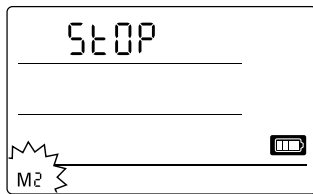

Select operating mode M2

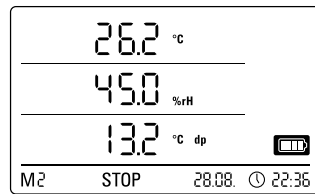

Display example for operating mode M2

The measuring function is active. The measurement values that were configured using the SmartGraph software are displayed in all three measurement value lines together with the previously selected sampling rate.

The logging function is not active in this operating mode. The displayed values are not saved into the memory. The word “STOP” (data logging inactive) appears where the saved measurement values are normally displayed.

Operating Mode M3

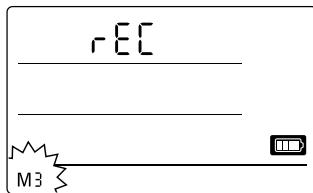

Select operating mode M3

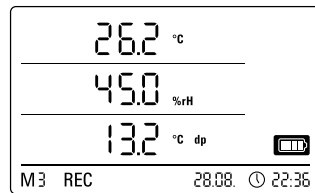

Display example for operating mode M3

The measuring and logging functions are active. The measurement values that were configured using the SmartGraph software are displayed in all three measurement value lines together with the previously selected sampling rate.

In addition a total of 20 measurement channels that have all been previously selected using the SmartGraph software can be saved into the measurement memory. The message “REC” (data logging active) appears where the saved measurement values are normally displayed.

Operating Mode M4

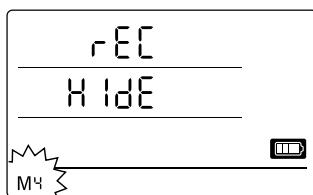

Select operating mode M4

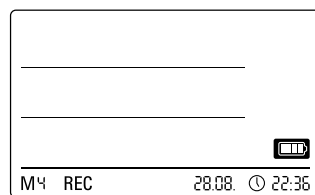

Display operating mode M4

The measuring and logging functions are active.
The display is deactivated.

No values are displayed in any of the three lines that normally display measurements. Up to a total of 20 measurement channels, which have all been previously selected using the SmartGraph software, can be saved into the measurement memory. The message “REC” (data logging active) appears where the saved measurement values are normally displayed.

6.2.2. Network Function (M51)

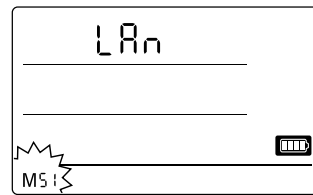

Select network function M51

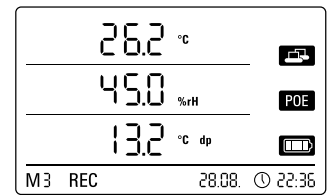

Display example of the network function M51

If the data logger is connected to a local network and the network function is active, then the software can be configured and the data can be read out from the data logger via this network.

A signal transmitted by the data logger via UDP enables the SmartGraph software to find the data logger in the local network automatically.

When the data logger is connected to the network for the first time (add network device), you may have to use the SmartGraph software to adapt the data logger network settings to conform with the existing network configuration. The factory setting is DHCP.

You will find more detailed information on the software in the software manual which you can call up using the Help function of your SmartGraph software.

The professional version of the SmartGraph software also allows you to call up and log current measurements and measurement values that have been saved in the data logger at random intervals via the network.

Use and Power Supply in Network Operation

If you intend to use the network card over a longer period, the data logger must be mounted on a wall.

The data logger consumes more power when the integrated network card is used.

When the network function has been activated, the data logger checks the network status automatically at regular intervals.

If an active local network cannot be identified, the data logger deactivates the network function independently after 12 minutes.

There is also an optionally available PoE model. This model can be powered directly from the mains.

6.2.3. Factory Setting (M52)

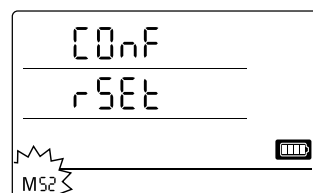

Select reset function M52

This function allows you to reset all the settings of your device to the factory settings.

6.2.4. Acoustic Function (M53)

The data logger has an acoustic signal which can be turned on or off by activating or deactivating the acoustic function. A symbol appears on the display when the acoustic function is activated.

When the acoustic function is activated, an alarm signal alerts the user when an alarm incident occurs. The alarm for one or more than one measurement must have been previously set using the SmartGraph software.



Select acoustic function M53

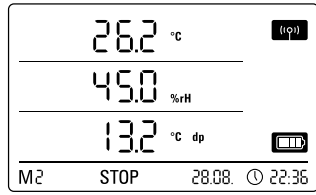

Display example of the acoustic function M53

When the acoustic function is activated, the data logger also emits a tone each time the mode selection key is pressed while navigating through the individual levels or when a specific mode is selected.

The data logger also emits a tone when you leave the settings level without a previous selection having been made.

7. Connecting and Configuring External Sensors

The data logger has a 5-pin, circular connector (M12) for connecting digital, bus-compatible sensors (BUS sensors) and a 10-pin connector with two independent input channels for connecting up to two analog sensors.

7.1 BUS Sensors

7.1.1 Connecting BUS Sensors

Attach the BUS sensor to the 5-pin circular connector on the data logger (see 23, chapter 3). The sensor is powered via the connector.

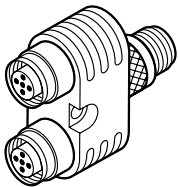

By using up to three Y-junctions (option), up to four digital BUS sensors can be connected to the data logger.

You will find more information about the BUS sensors that are currently available in the technical data in chapter 11.

7.1.2 Configuring BUS Sensors (M6x)

In order to use BUS sensors with the data logger, **each BUS sensor first** has to be individually logged on to the data logger.

The configuration process is only available when the data logger is not in the logging mode (M3 or M4).

You can configure BUS sensors on the data logger as described below. Alternatively, you can also do this directly using the SmartGraph software. *You will find more detailed information about configuring sensors using the software in the software manual, which you can call up using the Help function of your SmartGraph software.*

To configure on the data logger, connect the first BUS sensor to be logged on to the 5-pin circular connector 23 of the data logger and then - as described in chapter 6.2 - use the mode selection key to navigate to configuration mode M6x. The option to register the BUS sensor is shown on the display (n1 for the first sensor to n4 for the fourth sensor).

You can initiate the registration of the BUS sensor by briefly pressing the mode selection key. The display then switches to the scan mode and the connected BUS sensor is automatically detected and identified.

On identification the sensor is given a four digit BUS ID. The first two digits of this ID represent the sensor type (for example 71 for TFF sensors).

The last two digits represent the sensor number and are assigned automatically according to the log on sequence - from 01 for the first logged on sensor to 04 for the fourth logged on sensor.

Once the sensor has been logged on, a message indicating the BUS ID is also shown for your information – the message symbol flashes in the lower right corner of the display. You can close this message display by briefly pressing the mode selection key.



Tip: For future measurements, make a note of the BUS ID directly on the sensor.

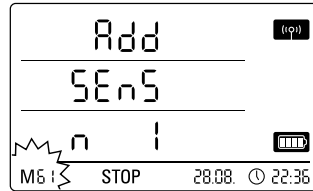

Display example: Select log on function M61 to log on the first BUS sensor (n1).

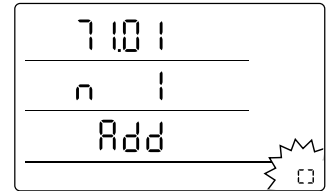

Display example: Message display indicating the BUS ID (71.01) for the first logged on BUS sensor.

If several sensors are to be used, in accordance with this procedure each individual sensor must first be connected to the data logger, logged on and registered with a BUS ID.

Alternatively, you can also configure the BUS sensors directly using the SmartGraph software.

You will find more detailed information on the software-related aspects concerning the configuration of BUS sensors in the software manual which you can call up using the Help function of your SmartGraph software.

7.1.3 Logging off BUS Sensors (M7x)

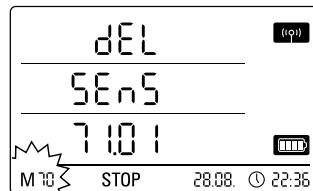

Display example: Select log off function M70 to log off the first logged on sensor.

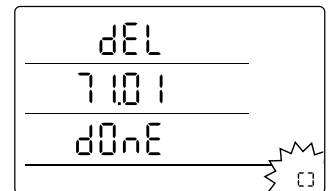

Display example: Message display indicating the BUS ID (71.01) of the logged off BUS sensor.

To log off a BUS sensor that was previously logged on to the data logger, use the mode selection key to navigate to configuration mode M7x. The option to remove the first BUS sensor is displayed.

It is not necessary to connect the sensor to the device in order to log off.

If several BUS sensors were logged on earlier and you want to remove a sensor other than the first one, press the mode selection key repeatedly until the BUS ID of the sensor to be removed is displayed.

You can now initiate the logging off of the BUS sensor by briefly pressing the mode selection key. Once the sensor has been logged off, a message indicating the BUS ID is also shown for your information – the message symbol flashes in the lower right corner of the display. You can close this message display by briefly pressing the mode selection key.

7.2 Connecting Analog Sensors

The data logger has a 10-pin connector with two independent input channels for connecting up to two analog sensors. Input channel 1 with pins 1, 3, 5, 7 and 9 and input channel 2 with pins 2, 4, 6, 8 and 10 (see 29, chapter 3).

Each of the two input channels supports the sensor configurations detailed in the following sub-sections.

7.2.1 Voltage Measurement Sensors: 0 - 1V

The positive pole of the voltage source is connected to terminal B and the negative pole is connected to terminal A, as shown in the diagram:

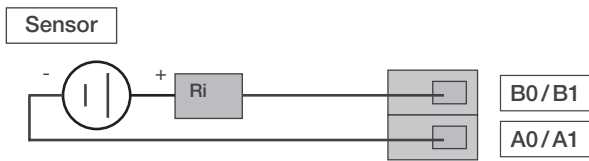

! *Important: The voltage input is a true differential input. If the sensor is connected to the data logger by means of cables of excessive length, it may be necessary to connect the sensor using shielded cables. The cable shield must be connected to the GND terminal.*

To log on and configure voltage measurement sensors on the data logger, follow the instructions in chapter 7.3.

7.2.2 Voltage Measurement Sensors: 2-wire 4 - 20 mA and 3-wire 0 - 20 mA

The circuit supports voltage measurements in 2-wire and 3-wire operation. The prerequisite for 2-wire operation is that the reference potential of the power supply to the sensor and the power supply to the data logger must be identical. In 2-wire and 3-wire operation, the power supply to the sensor is fed via terminal A0/A1.

Connection diagram for voltage measurement using the 2-wire technique:

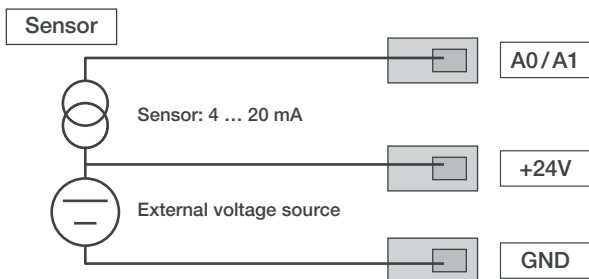

The sensor current is converted into a voltage at a burden resistor in the data logger. The burden resistor has a resistance of $<50 \Omega$. Both the sensor and the data logger can be powered via an external voltage source.

Connection diagram for voltage measurement using the 3-wire technique:

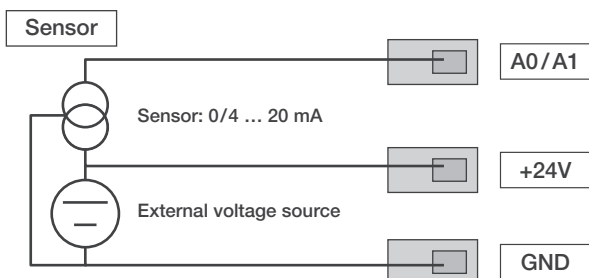

This circuit is used for sensors with power consumption greater than 4 mA, for example heated gas sensors.

To log on and configure voltage measurement sensors on the data logger, follow the instructions in chapter 7.3.

7.2.3 Pt100 Sensors in 3-wire and 4-wire Circuit

In the case of the 3-wire circuit, the Pt100 sensor is connected to the measurement circuit using 3 wires. The measuring current is fed into the sensor via line D0/D1. The resistance of the Pt100 sensor is determined from the terminal voltages B0/B1, C0/C1 and D0/D1:

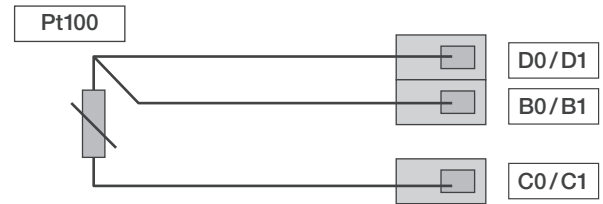

! *Important: The data logger is capable of compensating line resistances of up to 10Ω . Compensation typically reduces the effect of the line resistance by a factor of 100.*

In the case of the 4-wire circuit, the Pt100 sensor is connected to the measurement circuit using 4 wires. The measuring current is fed into the sensor via lines D0/D1 and C0/C1. The resistance of the Pt100 sensor is determined from the terminal voltages B0/B1 and A0/A1:

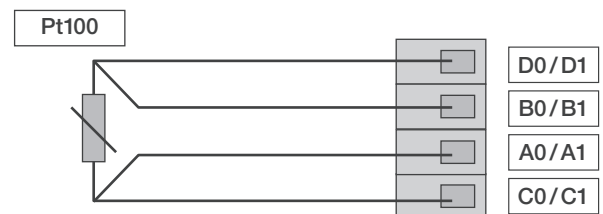

For precise temperature measurement, the 4-wire circuit is preferable.

To log on and configure Pt sensors on the data logger, follow the instructions in chapter 7.3.

7.2.3 Thermocouples

The data logger supports the connection of type J, K and S thermocouples. The positive pole of the thermocouple is connected to terminal B and the negative pole is connected to terminal A:



! *Important: Pay attention to polarity when connecting thermocouples.*

To log on and configure thermocouples on the data logger, follow the instructions in chapter 7.3.

7.3 Configuring Analog Sensors (M81)

In order to use analog sensors with the data logger, the specification of the analog sensors must be correctly configured on the data logger.

The configuration process is only available when the data logger is not in the logging mode (M3 or M4).

To configure the specification of a sensor for the first input channel, use the mode selection key as described in chapter 6.2 to navigate to configuration mode M81 (AN0); or to configure the specification of a sensor for the second input channel, use the mode selection key to navigate to configuration mode M81 (AN1). The option to configure the first analog sensor is shown on the display.

No sensor assignment is pre-set during initial commissioning at the factory. In the case of subsequent configurations, the last pre-set specification is assigned. By holding down the mode selection key, you can now switch to the configuration menu for the analog sensor specification.

Press the mode selection key repeatedly until the desired sensor specification is displayed. Finally, confirm the desired sensor specification by holding down the mode selection key.

Once the sensor has been logged on, a message indicating the selected sensor configuration is also shown for your information – the message symbol flashes in the lower right corner of the display. You can close this message display by briefly pressing the mode selection key.

Sample LCD displays: Sensor specification for logging on an analog sensor to the first input channel (AN0):

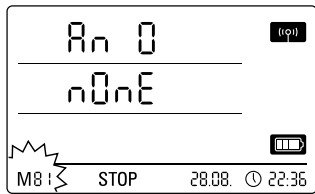

Selection to specify no sensor assignment on the first input channel.

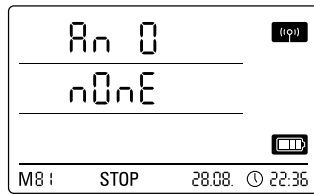

Status display showing that no sensor is logged on to the first input channel.

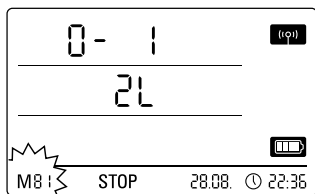

Selection of a voltage measurement sensor 0 - 1 V.

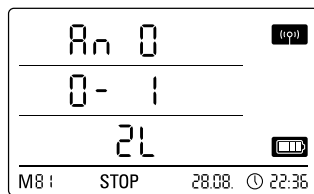

Status display showing that a voltage measurement sensor 0 - 1 V is logged on to the first input channel.

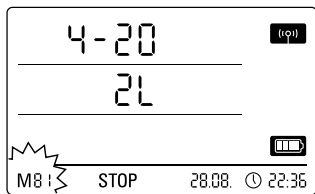

Selection of a current measurement sensor using the 2-wire technique.

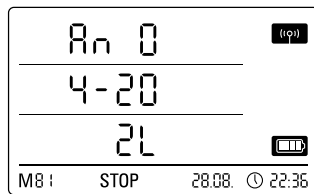

Status display showing that a current measuring sensor using the 2-wire technique is logged on to the first input channel.

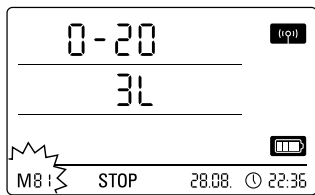

Selection of a current measurement sensor using the 3-wire technique.

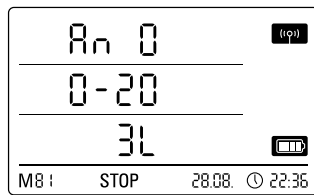

Status display showing that a current measuring sensor using the 3-wire technique is logged on to the first input channel.

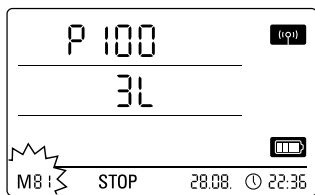

Selection of a Pt100 sensor using the 3-wire technique.

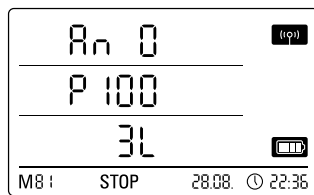

Status display showing that a Pt100 sensor using the 3-wire technique is logged on to the first input channel.

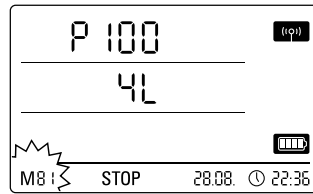

Selection of a Pt100 sensor using the 4-wire technique.

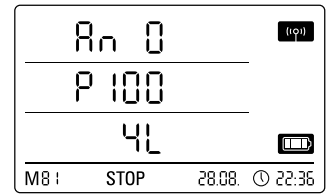

Status display showing that a Pt100 sensor using the 4-wire technique is logged on to the first input channel.

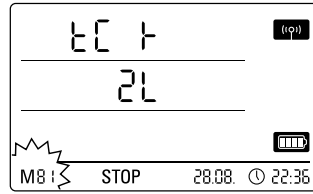

Selection of a type K thermocouple.

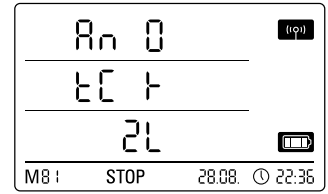

Status display showing that a type K thermocouple is logged on to the first input channel.

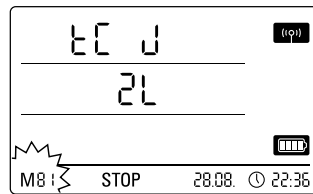

Selection of a type J thermocouple on the first input channel.

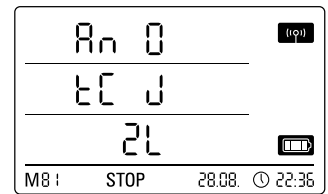

Status display showing that a type J thermocouple is logged on to the first input channel.

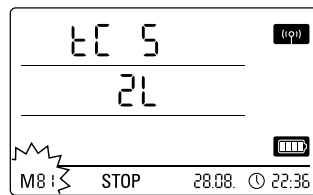

Selection of a type S thermocouple on the first input channel.

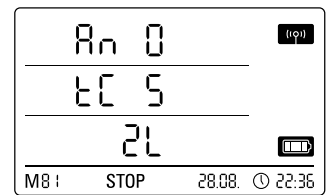

Status display showing that a type S thermocouple is logged on to the first input channel.

8. Measurement Value Display and Data Logging

8.1. Channel Groups and Measurement Channels

Each measurement variable captured by a connected sensor - in the defined unit of measurement - represents one channel group.

For example, a temperature sensor with defined units of measurement in °C or °F represents two channel groups (temperature in °C and temperature in °F).

The number of channel groups which a BUS sensor can measure depends on the sensor type. For example, the type TFF BUS sensor can measure seven different channel groups.

Analog sensors for measuring voltage or current can only measure one channel group; analog sensors for measuring temperature can measure two channel groups (°C and °F).

Again, four measurement channels are available for each channel group for the purpose of data logging: current measurement (curr), minimum measurement (min), maximum measurement (max) and mean measurement (mean).

With full sensor assignment and a total of four connected type TFF BUS sensors and two connected analog Pt100 sensors, the data logger is capable of capturing measurements from a total of 32 channel groups and 128 measurement channels, as shown in Table 1.

Table 1: Summary of Channel Groups (Measurement Variables) and Measurement Channels available on the Data Logger

Sensor assignment	Sensor type	Channel group (measurement variable)	Unit	Calculation channels available for measurement conversion	Measurement channels available for data logging (max. 20 channels storable) and display (max. 3 channels displayable)			
					curr	min	max	mean
BUS sensor 1	For example TFF sensor BUS class 71	Temperature	°C	–	curr	min	max	mean
		Temperature	°F	–	curr	min	max	mean
		Dew point	°C	–	curr	min	max	mean
		Dew point	°F	–	curr	min	max	mean
		Relative humidity	%	–	curr	min	max	mean
		Absolute humidity	g/m ³	–	curr	min	max	mean
		Mixing ratio	g/kg	–	curr	min	max	mean
BUS sensor 2 (with Y-junction)	For example TFF sensor BUS class 71	Temperature	°C	–	curr	min	max	mean
		Temperature	°F	–	curr	min	max	mean
		Dew point	°C	–	curr	min	max	mean
		Dew point	°F	–	curr	min	max	mean
		Relative humidity	%	–	curr	min	max	mean
		Absolute humidity	g/m ³	–	curr	min	max	mean
		Mixing ratio	g/kg	–	curr	min	max	mean
BUS sensor 3 (with Y-junction)	For example TFF sensor BUS class 71	Temperature	°C	–	curr	min	max	mean
		Temperature	°F	–	curr	min	max	mean
		Dew point	°C	–	curr	min	max	mean
		Dew point	°F	–	curr	min	max	mean
		Relative humidity	%	–	curr	min	max	mean
		Absolute humidity	g/m ³	–	curr	min	max	mean
		Mixing ratio	g/kg	–	curr	min	max	mean
BUS sensor 4 (with Y-junction)	For example TFF sensor BUS class 71	Temperature	°C	–	curr	min	max	mean
		Temperature	°F	–	curr	min	max	mean
		Dew point	°C	–	curr	min	max	mean
		Dew point	°F	–	curr	min	max	mean
		Relative humidity	%	–	curr	min	max	mean
		Absolute humidity	g/m ³	–	curr	min	max	mean
		Mixing ratio	g/kg	–	curr	min	max	mean
Analog sensor 1 on input channel 1 (An0)	Voltage measurement 0 - 1 V	Voltage V	V	Yes, see Table 2	curr	min	max	mean
	Current measurement using 2-wire technique 4 - 20 mA	Current strength	mA		curr	min	max	mean
	Current measurement using 3-wire technique 0 - 20 mA	Current strength	mA		curr	min	max	mean
	Pt100 temperature measurement using 3-wire technique	Temperature	°C	–	curr	min	max	mean
	Pt100 temperature measurement using 3-wire technique	Temperature	°F	–	curr	min	max	mean
	Pt100 temperature measurement using 4-wire technique	Temperature	°C	–	curr	min	max	mean
	Pt100 temperature measurement using 4-wire technique	Temperature	°F	–	curr	min	max	mean
	Temperature measurement using type K thermocouple	Temperature	°C	–	curr	min	max	mean
	Temperature measurement using type K thermocouple	Temperature	°F	–	curr	min	max	mean
	Temperature measurement using type J thermocouple	Temperature	°C	–	curr	min	max	mean
	Temperature measurement using type J thermocouple	Temperature	°F	–	curr	min	max	mean
	Temperature measurement using type S thermocouple	Temperature	°C	–	curr	min	max	mean
	Temperature measurement using type S thermocouple	Temperature	°F	–	curr	min	max	mean
	Analog sensor 2 on input channel 2 (An1)	Voltage measurement 0 - 1 V	Voltage V	V	Yes, see Table 2	curr	min	max
Current measurement using 2-wire technique 4 - 20 mA		Current strength	mA	curr		min	max	mean
Current measurement using 3-wire technique 0 - 20 mA		Current strength	mA	curr		min	max	mean
Pt100 temperature measurement using 3-wire technique		Temperature	°C	–	curr	min	max	mean
Pt100 temperature measurement using 3-wire technique		Temperature	°F	–	curr	min	max	mean
Pt100 temperature measurement using 4-wire technique		Temperature	°C	–	curr	min	max	mean
Pt100 temperature measurement using 4-wire technique		Temperature	°F	–	curr	min	max	mean
Temperature measurement using type K thermocouple		Temperature	°C	–	curr	min	max	mean
Temperature measurement using type K thermocouple		Temperature	°F	–	curr	min	max	mean
Temperature measurement using type J thermocouple		Temperature	°C	–	curr	min	max	mean
Temperature measurement using type J thermocouple		Temperature	°F	–	curr	min	max	mean
Temperature measurement using type S thermocouple		Temperature	°C	–	curr	min	max	mean
Temperature measurement using type S thermocouple		Temperature	°F	–	curr	min	max	mean

Table 2: Available Calculation Channels for Measurement Conversion

Assignable units:	counts, logic, digits, °C, °F, K, °Cdp, °Fdp, %RH, g/kg, g/m ³ , µm, mm, cm, dm, m, km, in, mil, ft, mi, m/s, km/h, kts, ppm, mV, V, mA, A, Hz, kHz, bar, mbar, Pa, mPa, hPa, kPa, m ³ , l, s, ms, µs, %, °, mm/h, m ³ /h, l/m ² , in/h, mil/h, g, kg
Assignable sensor types:	Temperature, relative humidity, absolute humidity, dew point, battery voltage, voltage, current, absolute air pressure, relative air pressure, building moisture, flow velocity, mixing ratio, CO2 concentration, particle 0.1 µm, particle 0.2 µm, particle 0.3 µm, particle 0.5 µm, particle 1 µm, particle 5 µm, particle 10 µm, particle x µm, particle y µm, particle z µm, unknown, inactive, cooling limit temperature, global radiation, daylight, precipitation amount, wind speed, wind direction, analog/digital input, soil moisture, leaf wetness

8.2 Calculation Channels for Measurement Conversion

Using the SmartGraph software, analog sensors that deliver a current or voltage value can be used as calculation channels for measurement conversion. Calculation channels allow input variables from analog sensors that deliver a current or voltage value to be converted into the actual measurement variable. Units of measurement, conversion parameters and decimal place settings can be specified and assigned to a sensor type (see Table 2).

You will find more detailed information on how to use the software to configure calculation channels in the software manual which you can call up via the Help function of your SmartGraph software.

8.3 Displaying Measurement Values

One of the channel groups specified in Table 1 can be configured to display measurement values on each of the three lines provided on the display for this purpose. The current measurement is always displayed.

8.4 Data Logging

When you select operating mode M3 or M4, the data logger is in the logging mode (REC) and the measurement values of the measurement channels pre-selected for logging are stored in the device.

Up to 20 of the measurement channels specified in Table 1 can be logged in parallel and stored in the memory of the measuring device.

Logging begins immediately as soon as operating mode M3 or M4 is selected and is executed in the ring mode. This means that logging does not end when the memory is full but is permanently ongoing. For this purpose, the oldest values are continuously overwritten with the most recent data.



Tip: The current, minimum, maximum and mean measurement values of a channel group represent an individual measurement channel in each case. If you want these measurements to be available for subsequent documentation and analysis, each of these measurement channels must be pre-selected for logging at the memory organization level, as subsequent computation of these measurements is not available on the software side.

Using the software, you can set up the individual specifications for the type, duration and scope of data logging in the logging mode. You will find detailed information about this in the software manual.

9. Alarm Function

9.1 Alarm Configuration

The data logger management can be used to configure an alarm for each individual measuring channel which has been selected for display or logging.

First you must define both an upper and a lower alarm threshold so as to set a corridor within which the values are deemed to be good. The data logger triggers the alarm as soon as the measured value is outside this corridor, i.e. one of the thresholds has been exceeded.

Please note: The alarm function will only be displayed for the channel groups of the three measurement channels which have been previously selected to be displayed and only in the operating modes M2 and M3.

Alarm incidents of further selected measurement channels in logging mode are saved regardless of whether they have been selected to be displayed or not. This means that alarm incidents of measurement channels that have not been selected for display but which have been selected for logging will be saved.

All selected alarm incidents are also recorded when the display has been deactivated in operating mode M4.

9.2 Alarm Symbol on the Display

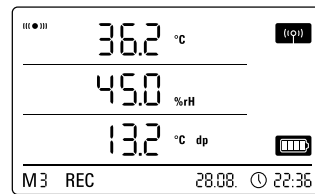

Display example for an alarm incident of the measurement channel displayed in the first measurement line.

The alarm will only appear on the display for measurement values which have been selected to be displayed and which have been configured with an active alarm function. When an alarm has been triggered on one of these measurement channels, an alarm symbol appears next to the measurement value for this specific channel. The symbol continues to flash until the measurement value returns to the preset corridor.

The alarm symbol stops flashing as soon as the measured value is within the selected thresholds. The alarm symbol remains on the display.

This is to show the user that an alarm has been triggered and that an alarm incident has occurred. If the threshold values are exceeded again, then the alarm symbol starts to blink again.

The alarm symbol disappears when the memory is read out.

Alarm display

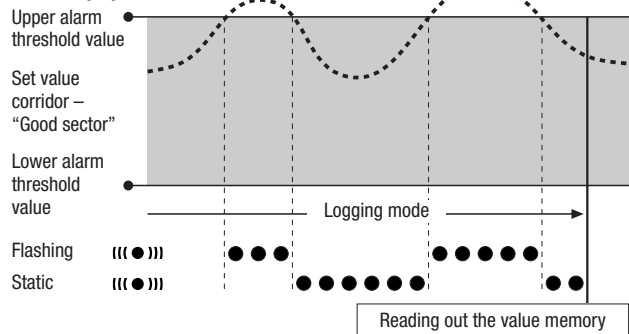

A hysteresis can also be set which switches off the alarm when the measured value is once again within the corridor.

9.3 Acoustic Alarm

When an alarm is triggered when the acoustic function is active (see chapter 6.2.4. Acoustic Function), an alarm tone sounds in addition to the alarm symbol on the display. The logger stops emitting the tone when the measured value is within the corridor.

9.4. Using the Alarm Hysteresis

If you use the alarm function with an alarm hysteresis, the alarm will be triggered and recorded every time the alarm thresholds are exceeded.

If the corridor between the selected alarm thresholds is very narrow, the alarm will be triggered more often.

If, for example, you have selected 24°C as your upper alarm threshold for the room temperature and 10°C for your lower alarm threshold and the room temperature fluctuates between 23.5 and 25°C during the entire measuring period, then this would lead to the alarm being triggered and recorded much more often than would perhaps otherwise be the case during a normal measuring period.

In order to prevent this from happening, you can set an alarm hysteresis. By doing so you are defining a value which has to be reached in the selected value corridor, the so-called “good sector” to switch off the alarm.

The alarm hysteresis is set to 1°C in the previous example. This means that the alarm will be triggered when the measured value has exceeded 24°C and then switched off again when it reaches 23°C.

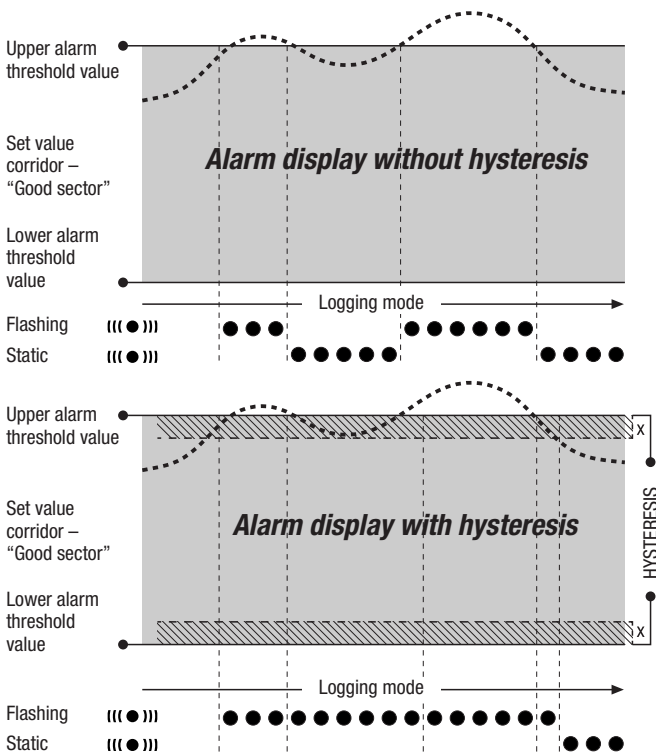

Only use batteries which are permissible according to the technical specifications. Other battery types can cause faults. Do NOT use rechargeable batteries.

Do NOT dispose of used batteries in your household waste. Do NOT throw into an open fire or water. Please dispose of these batteries in a proper manner in accordance with existing regulations.

10.2. Installation During Mobile Operation

The data logger can be placed at any random position during mobile operation. Please make sure that the permissible ambient conditions are observed (see Technical Data). Because of its compact size, the data logger can be easily concealed during mobile operation.

10.3. Mounting the Logger on a Wall

If stationary logging is to be carried out, the data logger can be mounted on a wall or fixed to a mounting rail. A mounting rail is included in the scope of delivery.

! *The wall mount must be used if the logger is being used in network operation. You will find more information on network operation in chapter 6.2.2.*

10.4. Changing Locations

A change of location, i.e. from a cold to a warm place (for example when the device has been left in a car overnight before being brought into a warm room for measuring), can lead to condensation forming on the printed circuit board.

This physical phenomenon, which cannot be avoided through any change in the construction of such a measuring device, will invariably lead to incorrect readings. Please wait approximately 5 minutes to give the device enough time to adapt to its new surroundings before carrying out measuring.

10. Cleaning and Maintenance Instructions

10.1. Replacing the Batteries

When the message “LO bAtt” appears on the display, the batteries have to be replaced.

! *The data logger cannot log data while the batteries are being replaced. If you have to interrupt a logging process, please ensure that the data logger is set to operating mode M1 or M2 before the batteries are replaced.*

Open the battery compartment and remove the used batteries. Place the new batteries in the battery compartment. Make sure that the poles are properly aligned.

The clock continues to give the correct time for at least a minute while the batteries are being replaced.

11. Technical Data

Data logger with external sensors		
Voltage Input 0 - 1 V	Measuring range	0 ... 1 V
	Accuracy	$\pm 200 \mu\text{V} \pm 0.1\%$ of measurement
	Resolution	$< 500 \mu\text{V}$
Current Measurement	Measuring range	2-wire operation: 4 ... 20 mA, 3-wire operation: 0 ... 20 mA
	Accuracy	$\pm 4 \mu\text{A} \pm 0.1\%$ of measurement
	Resolution	$< 5 \mu\text{A}$
	Burden resistor	approx. 50 Ω
K-type Thermocouple	Measuring range	-200°C ... 1,200°C
	Accuracy	$\pm 1^\circ\text{C} \pm 0.5\%$ of measurement at -200°C ... 0°C, $\pm 1^\circ\text{C} \pm 0.2\%$ of measurement at 0°C ... 1,200°C
	Resolution	$< 0.2^\circ\text{C}$
J-type Thermocouple	Measuring range	-200°C ... 1,200°C
	Accuracy	$\pm 1^\circ\text{C} \pm 0.5\%$ of measurement at -200°C ... 0°C, $\pm 1^\circ\text{C} \pm 0.2\%$ of measurement at 0°C ... 1,200°C
	Resolution	$< 0.2^\circ\text{C}$
S-type Thermocouple	Measuring range	-50°C ... 1,700°C
	Accuracy	$\pm 1^\circ\text{C} \pm 0.5\%$ of measurement at -50°C ... 0°C, $\pm 1^\circ\text{C} \pm 0.2\%$ of measurement at 0°C ... 1,700°C
	Resolution	$< 0.2^\circ\text{C}$
Pt100	Measuring range	-200°C ... 500°C
	Accuracy	$\pm 0.2^\circ\text{C} \pm 0.1\%$ of measurement
	Resolution	$< 0.02^\circ\text{C}$
Memory Organization	Sampling interval	10/30 s, 1/10/12/15/30 min, 1/3/6/12/24 h
	Storage interval	1/10/12/15/30 min, 1/3/6/12/24 h
	Data storage	16 MB, approx. 3,200,000 measurements
	Data logging	up to 20 parallel measurement channels
Equipment and Dimensions	LC display	W 90 x H 64 mm
	Housing	Plastic
	Dimensions	L 180 x W 32 x H 78 mm
	Weight	approx. 250 g
	Interfaces	USB, LAN, RS485 (sensor BUS)
Power Supply	Internal	4 x LR6 AA batteries, battery service life > 1 year (dependent on connected sensors and configuration)
	External	USB, LAN (PoE version), connectors for external voltage source for power supply to sensors
Permissible Operating/ Ambient Conditions	Air temperature	-20°C to +50°C
	Relative humidity	0 to 95% RH, < 20 g/m ³ (non-condensing)
	Altitude	10,000 m above sea level
Scope of Delivery	Standard	Measuring instrument, CD ROM containing SmartGraph 3 PC software for graphic and numeric representation of the measurement data analysis and operating manual, USB connection cable and batteries
	Optional	Measuring instrument in PoE version, TFF sensors

12. Error Codes

Sensor	Status	Measuring range	Code
0 ... 1 V	Negative polarity	approx. < -0.024 V	0x53 (CHANNEL_UNDERRANGE)
	Threshold range	-0.024 V ... 0.000 V	Displayed: 0.000V
	Normal operation	0.000 V ... 1.000 V	
	Threshold range	1.000 V ... 1.024 V	Displayed: 1.000V
	Overvoltage	approx. > 1.024 V	0x52 (CHANNEL_OVERRANGE)
	Special case: open		Floating input, e.g. CHANNEL_OVERRANGE, also 0x52
4 ... 20 mA	Negative polarity	approx. < -0.48 mA	0x53 (CHANNEL_UNDERRANGE)
	Sensor failure	approx. -0.48 mA ... 0.30 mA	0x55 (MEAS_UNABLE)
	Residual current	0.30 mA ... 3.00 mA	0x51 (VALUE_UNDERFLOW)
	Threshold range	3.00 mA ... 4.00 mA	Displayed: 04.00mA
	Normal operation	4.00 mA ... 20.00 mA	
	Threshold range	20.00 mA ... 20.48 mA	Displayed: 20.00mA
	Over current	approx > 20.48 mA	0x52 (CHANNEL_OVERRANGE)
0 ... 20 mA	Negative polarity	approx. < -0.48 mA	0x53 (CHANNEL_UNDERRANGE)
	Threshold range	-0.48 mA ... 0.00 mA	Displayed: 0.00mA
	Normal operation	0.00 mA ... 20.00 mA	
	Threshold range	20.00 mA ... 20.48 mA	Displayed: 20.00mA
	Over current	approx > 20.48 mA	0x52 (CHANNEL_OVERRANGE)